

VB41775

Vidage automatique à câble

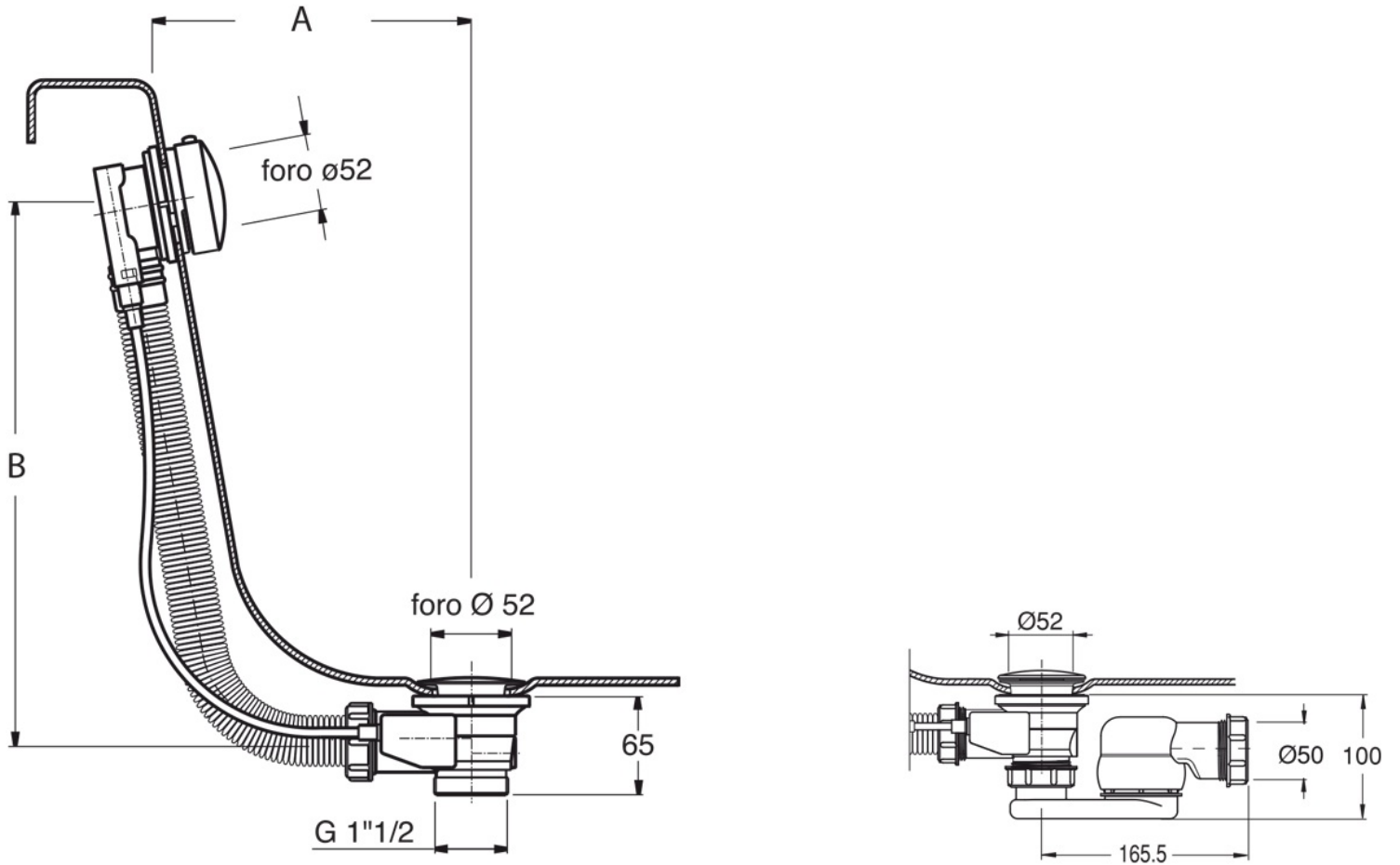

$$A+B < 58+10$$

