

- Tutti i prodotti Cristina rubinetteria sono coperti da una Garanzia Convenzionale (Commerciale) secondo i termini e le modalità indicati nel sito www.cristinarubinetteria.com. L'azienda si riserva il diritto di apportare le modifiche che riterrà opportune, utili a migliorare la funzionalità e l'estetica dei propri prodotti senza preavviso.

- All Cristina Rubinetterie products are covered with a commercial conventional guarantee according to the terms indicated on the web site www.cristinarubinetteria.com.

The firm reserves the right to make any appropriate modifications to improve functionality and design of its products without notice.

- Tous les produits Cristina Rubinetterie sont couverts par une Garantie Conventiionnelle (Commerciale) selon les termes et les modalités indiquées sur le site www.cristinarubinetteria.com. L'entreprise se réserve le droit d'apporter les modifications qui seront retenu appropriés et utiles pour améliorer la fonctionnalité et l'esthétique de ses produits sans aucun préavis.

- Alle Cristina Rubinetterie Produkte sind mit konventioneller Garantie (Handelsgarantie) gemäß den auf der Website www.cristinarubinetteria.com angegebenen Bedingungen und Modalitäten gedeckt. Unsere Firma behält sich das Recht vor, die angemessenen Änderungen, die die Funktion und die Ästhetik ihrer eigenen Produkte verbessern können, ohne Vorankündigung vorzunehmen.

- Todos los productos Cristina rubinetteria están cubiertos por una Garantía Convenzional (Comercial) según los términos y la modalidad indicados en la página web www.cristinarubinetteria.com. La Compañía se reserva el derecho a realizar modificaciones que estime conveniente, para mejorar la funcionalidad y la estética de sus productos sin previo aviso.

ISTRUZIONI DI MONTAGGIO

INSTALLATION INSTRUCTIONS

NOTICE DE MONTAGE

MONTAGEANLEITUNG

INSTRUCCIONES DE MONTAJE

CRISTINA

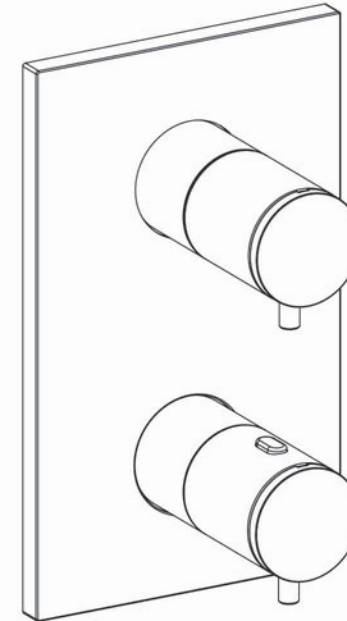

THERMOSTATIC EXTERNAL PARTS

XT852 - XQ852 - XP852 - XC852 - XE852

*Legge n.166/2009 del 25 settembre 2009 - Per quanto previsto dalla legge si dichiara che alcuni componenti di questo prodotto sono di importazione extra UE.
Testati, assemblati e collaudati all'interno del nostro stabilimento.
*Bylaw n.166/2009 dd.25th September 2009 - As bylaw enacted we state that some components of this product are imported from extra-Eu countries.
Tested, assembled and inspected inside our factory.*



Via Fava, 56 - 28024 Gozzano - NO - ITALY
Phone (+39) 0322 9545 - Fax (+39) 0322 956556
P.IVA 00309260032
www.cristinarubinetteria.com

AT16759A11 05/2014

scala 1:2



Dati tecnici - Standard Specifications - Donnée Techniques - Technische standarddaten - Datos Técnicos

- Pressione d'esercizio consigliata / *Recommended operational pressure* / Pression d'exercice recommandée / Empfohlener Betriebsdruck / *Presión de trabajo recomendada* : 1-5 bar
- Pressione Massima di prova / *Maximum test pressure* / Pression maximum de preuve / Prüf-Höchstdruck / *Presión máxima de prueba* :16 bar
- Temperatura Massima acqua calda / *Maximum hot water temperature* / Température maximum eau chaude / *Warmwasser-Höchsttemperatur* / Temperatura máxima agua caliente : 80 °C
- Temperatura consigliata / *Recommended temperature* / Température conseillée / *Empfohlene Temperatur* / Temperatura recomendada : 50-60 °C
- Differenza di pressione tra acqua calda e fredda / *Pressure difference between hot and cold water* / Différence de pression entre eau chaude et eau froide / *Druckunterschied zwischen Warm- und Kaltwasser* / Diferencia de presión entre agua caliente y fría: max. 1,5 BAR
- Installazione di filtri per l'acqua a monte dell'impianto e installazione al prodotto di tutti i filtri che lo accompagnano. **We suggest to install water filters at the beginning of the installation** / Etablir des filtres pour l'eau en amont de l'installation et installation au produit de tous les filtres qui l'accompagnent. **Installation von Filtern an der Wasserversorgungsanlage und Installation von allen dazu gelieferten Filtern am Produkt.** / Se aconseja utilizar filtros para el agua en la entrada de la red

7. Nota bene:
 - qualora non siano presenti le condizioni sopraindicate ai punti 1,4,5 e 6 il prodotto potrebbe non funzionare o funzionare in modo non ottimale.
 - Qualora al momento dell'installazione, prima della posa sul sanitario, vengano riscontrate anomalie dovute alla finitura superficiale, potrà essere richiesta la sostituzione completa del rubinetto.
Warning :
 - *if the above mentioned conditions (see points 1,4,5 and 6) are not observed, the product may not correctly work or not work at all.*
 - *if during installation, before setting the product on the sanitary fittings, faults due to the special finishing are evident you may require the replacement of the tap.*
 Nota bene :
 - Si les conditions susvisé aux points 1, 4, 5 et 6, ne sont pas présentes, le produit pourrait ne fonctionner pas ou fonctionner pas en façon optimale.
 - Si pendant l'installation, avant la pose sur le sanitaire, on va rencontrer des anomalies dues à la finition superficielle, on peut demander le remplacement complet du robinet.
Bemerkung:
Bei der Nicht-Beachtung der am Punkt 1, 4, 5 und 6 erwähnten Konditionen könnte das Produkt nicht oder nicht gut funktionieren.
Wenn Abweichungen bei der oberflächlichen Ausführung noch vor dem Einbau der Sanitätsanlage festgestellt werden, kann der Austausch der kompletten Armatur angefordert werden.
 Nota bien:
 - Si no se presentan las condiciones indicadas encima en los puntos 1, 4, 5 y 6 el producto podría no funcionar o funcionar de manera no óptima;
 - Si al momento de la instalación, antes de colocarse en el sanitario, se observan anomalías del acabado superficial, puede solicitarse la sustitución completa del grifo.

THERMOSTATIC EXTERNAL PARTS scala 1:10

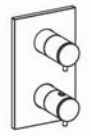

XT852

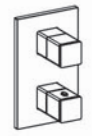

XQ852

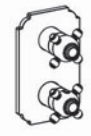

XP852

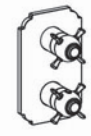

XC852

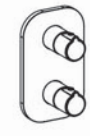

XE852

Pulizia - Cleaning - Nettoyage - Pflegeanleitung - Limpieza

Per una corretta pulizia dell'articolo, lavare esclusivamente con acqua e sapone neutro, risciacquare ed asciugare con un panno morbido. Evitare assolutamente l'impiego di alcool, solventi, detersivi contenenti sostanze corrosive o acide (acido cloridrico, formico, acetico, fosforico), spugne abrasive e tamponi con fili metallici.
For a correct cleaning of the article use only water and neutral soap, rinse and dry with a soft cloth. Don't use alcohol, solvents, detergents containing corrosive or acid substances (hydrochloric, formic, acetic and phosphoric acid), abrasive sponges and plugs with metallic thread.
 Pour nettoyer correctement le article, utilisez simplement de l'eau et du savon neutre, rincez-le et essuyez-le avec un chiffon doux. A éviter absolument tout emploi d'alcool, de solvants, de détergents contenant des substances corrosives ou acides (acide chlorhydrique, formique, acétique et phosphorique), des éponges abrasives et des tampons métalliques.
Reinigen Sie die Artikel nur mit Wasser und seifigen Waschmittel, mit einem weichen Tuch reinigen und abtrocknen. Keine alkoholhaltigen Lösungsmittel, scheuernden oder ätzenden Mittel (Salzsäure, Chlorwasserstoffe, Ameisensäure, Essigsäure, Phosphorsäure), Waschlappen mit synthetischen oder metallischen Fasern benutzen.
 Para una correcta limpieza del artículo, utilizar exclusivamente agua y jabón neutral, enjuagar y secar con un paño suave. Evitar absolutamente el uso de alcohol, disolventes y detergentes que contengan sustancias corrosivas o ácidas (ácido clorhídrico, fórmico, acético y fosfórico), espumas abrasivas o tampones con hilos metálicos, en caso contrario, se pueden dañar irreversiblemente las superficies tratadas.

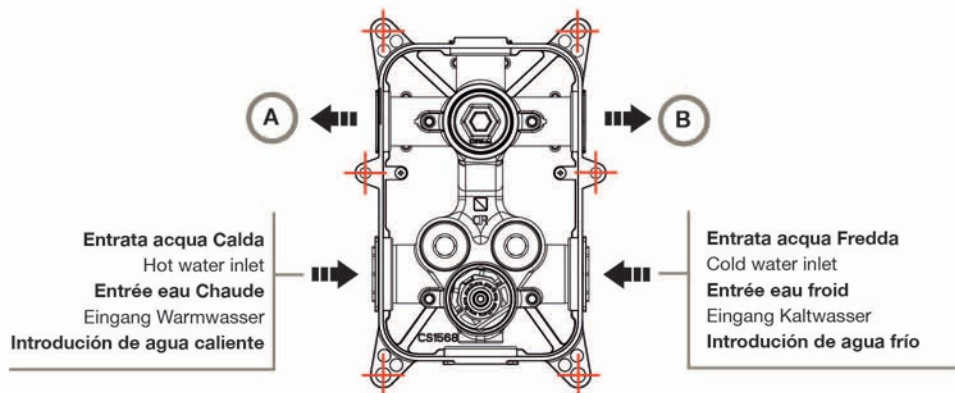

art. XT852 - XQ852 - XP852 - XC852 - XE852



Connessione per 2 uscite
 Connection for 2 outputs
Connexion pour 2 sorties
 Anschluss für 2 Ausgänge
Conexión para 2 salidas

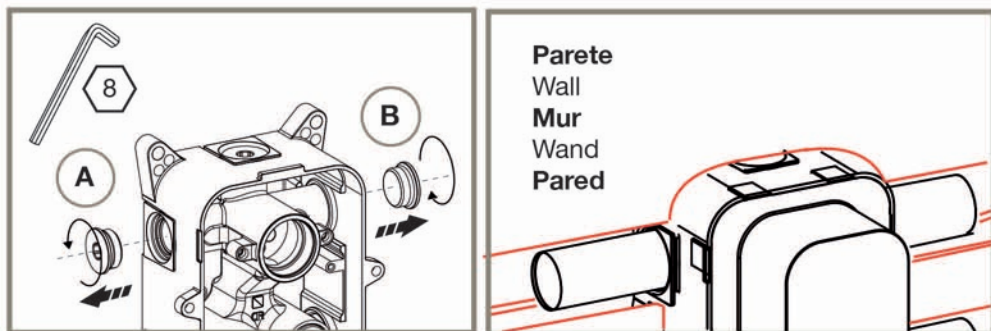

XT852

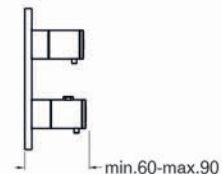
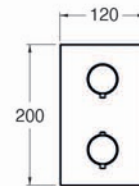

XQ852

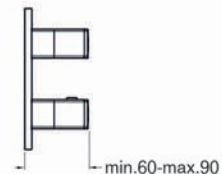
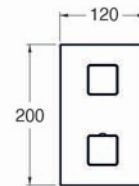
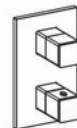

XP852

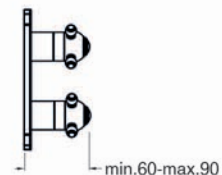
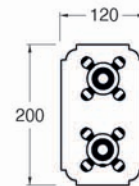

XC852

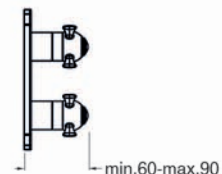
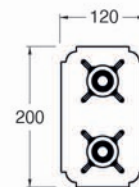

XE852

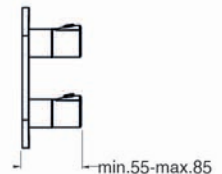
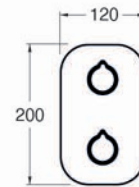

I - L'installazione deve essere eseguita da personale qualificato!
 - Spurgare le tubazioni prima di collegare il rubinetto all'impianto.

UK - Installation performed by qualified personnel!
 - Before connecting to mains, bleed the pipes to avoid damage.

F - L'installation effectuée par un personnel qualifié!
 - Avant de brancher le robinet au réseau hydraulique, purger la tuyauterie.

D - Installation von qualifiziertem Personal!
 - Entleeren Sie die Leitungen bevor Sie die Armaturen an die Wasserversorgung anschließen.

E - Instalación realizada por personal calificado!
 - Antes de conectar el grifo a la red hidráulica purgar las tuberías.



Montaggio e Pezzi di Ricambio - Installation And Spare Parts - Montage et pièces détachées
 Montage und Ersatzteile - Montaje y piezas de recambio

XT851 - XT852 - XT853

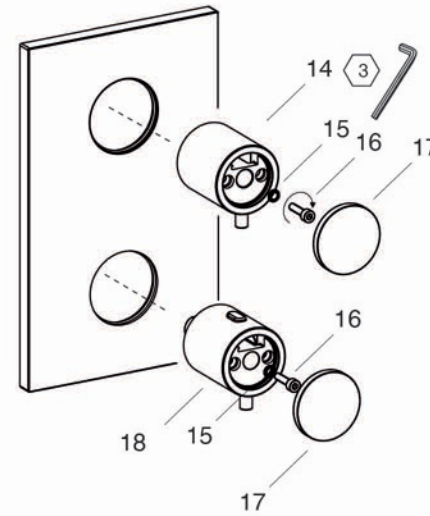

XE851 - XE852 - XE853

(*)
 n.14 = L 45.5 mm
 n.15 = L 52.4 mm
 n.18 = L 50 mm
 n.19 = L 55 mm

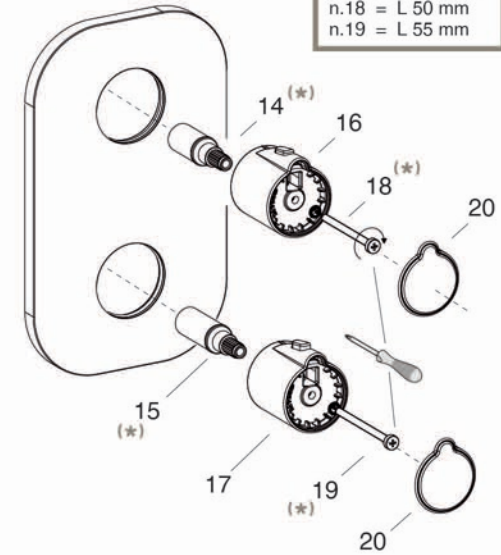

XQ851 - XQ852 - XQ853

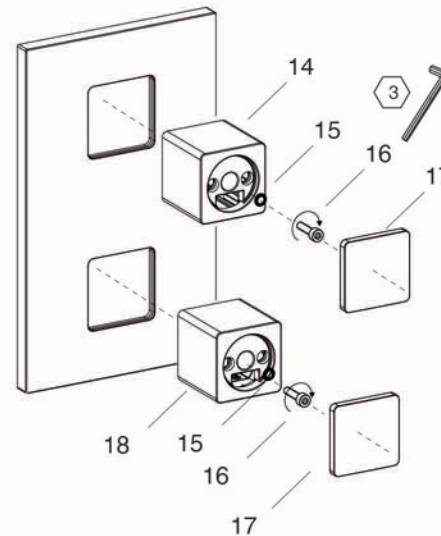

**XC851 - XC852 - XC853
 XP851 - XP852 - XP853**

